

1

2

3

4

A

A

B

B

C

C

D

D

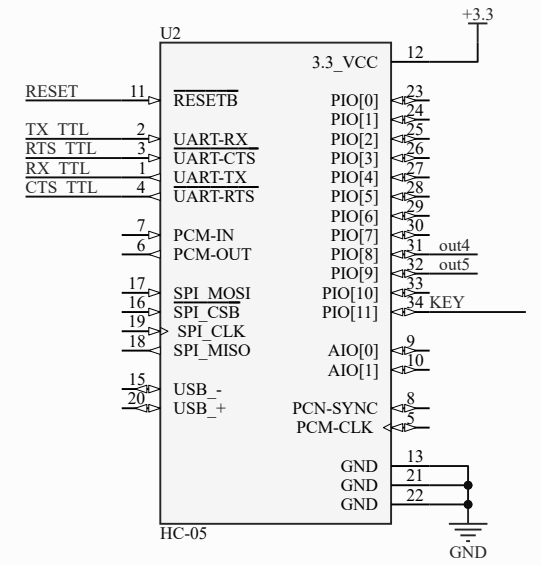
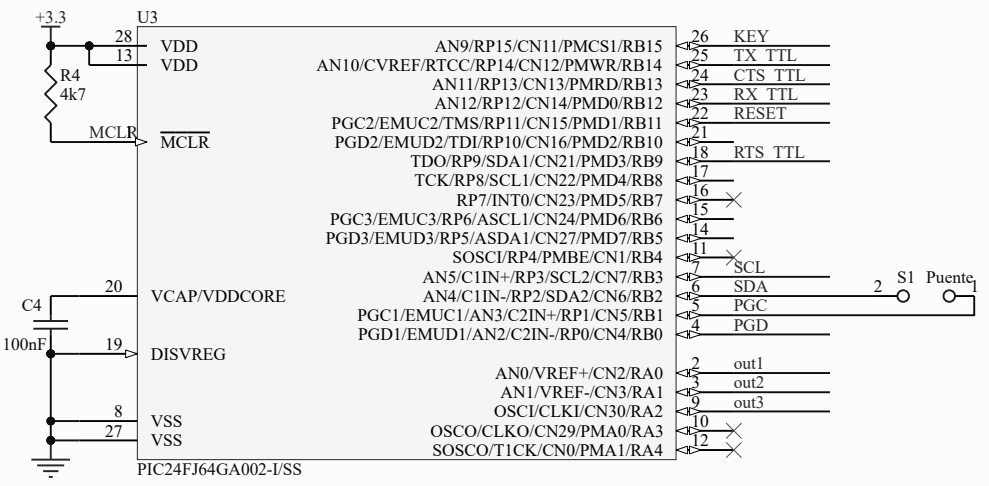
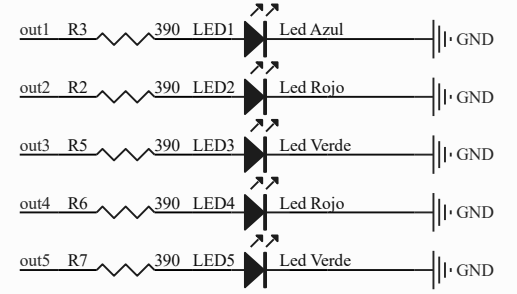
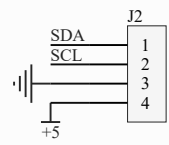
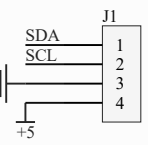
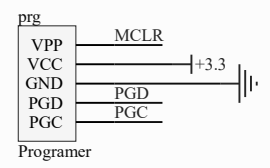
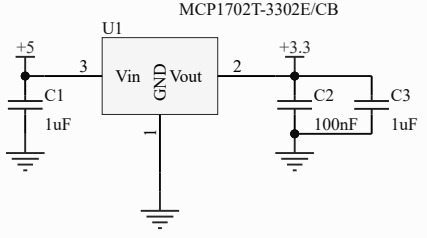

Title		
Size	Number	Revision
A4		
Date:	4/17/2024	Sheet of
File:	C:\Users\...RFIM022 - HRD BLUETOOTH\B_Sch.Dwg	

1

2

3

4